

Continental 
The Future in Motion



BICYCLE

Tire Range 2022/23

CONTENT ²²/₂₃

04 MOUNTAINBIKE



18 ROAD



30 GRAVEL



34 URBAN / TOUR





48 TUBULAR







56 E-TIRES





LEGEND ARTICLE LISTS

 Available from quarter...
 Safety Level

 Handmade in Germany
 Color/sidewall

 E-Bike up to 25 km/h
 E-Bike up to 50 km/h

 Tubeless Ready
 Dynamo compatible



MOUNTAINBIKE _____ **04**

NEW	Die neue Gravity Range _____	06
NEW	Xynotal _____	08
NEW	Kryptotal Fr _____	09
NEW	Kryptotal Re _____	10
NEW	Argotal _____	11
NEW	Hydrotal _____	12
	Mountain King _____	13
	Cross King _____	14
	Race King _____	15
	Ruban _____	16
	eRuban _____	17

ROAD _____ **18**

	Grand Prix 5000 S TR _____	20
	Grand Prix 5000 _____	21
	Grand Prix _____	22
	Grand Prix 4-Season _____	23
	Grand Prix Classic _____	24
	Ultra Sport III _____	25
	Gatorskin _____	26
	Gator Hardshell _____	27
	Grand Sport Race _____	28
	Hometrainer _____	29

GRAVEL _____ **30**

	Terra Speed _____	31
	Terra Trail _____	32
NEW	Terra Hardpack _____	33

URBAN/TOUR _____ **34**

NEW	eCONTACT Plus _____	35
	CONTACT Plus _____	36
	CONTACT Plus City _____	37
	CONTACT II _____	38
	CONTACT Urban _____	39
	CONTACT Speed _____	40
	CONTACT Spike _____	41
	Top CONTACT II / _____	
	Top CONTACT Winter II Premium _____	42
	Super Sport Plus _____	43
	Grand Prix Urban _____	44
	Urban Taraxagum _____	45
	RIDE Tour _____	46
	RIDE City _____	47

TUBULAR _____ **48**

	Competition _____	49
NEW	Competition TT _____	50
	Sprinter _____	51
	SprinterGatorskin _____	52
	Giro _____	53
	Sonderklasse II _____	54
	Tempo II _____	55

E-TIRES _____ **56**

OTHER _____ **58**

	TIRES AND SIZES _____	58
	TUBES _____	60
	ACCESSORIES _____	62
	TECHNIC _____	64
	TECH SUPPORT _____	68

MOUNTAIN BIKE

XYNOTAL, KRYPTOTAL, ARGOTAL, HYDROTAL

The all new Gravity Range



[instagram.com/conti_mtb](https://www.instagram.com/conti_mtb)





4 NAMES, 5 PATTERNS, INF

The all new Gr

CASIN

TRAIL

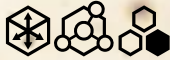

ENDURO

TERRAIN

HARD
PACK



MIXED

LOOSE

MUD

27.5" X 2.4

XY
XYNOTAL

29" X 2.4

XY
XYNOTAL

27.5" X 2.4

XY
XYNOTAL

29" X 2.4

XY
XYNOTAL

27.5" X 2.4 Fr

KR
KRYPTOTAL

29" X 2.4 Fr

KR
KRYPTOTAL

27.5" X 2.4 Fr

KR
KRYPTOTAL

29" X 2.4 Fr

KR
KRYPTOTAL

27.5" X 2.4 Re

KR
KRYPTOTAL

27.5" X 2.6 Re

KR
KRYPTOTAL

29" X 2.4 Re

KR
KRYPTOTAL

29" X 2.6 Re

KR
KRYPTOTAL

27.5" X 2.4 Re

KR
KRYPTOTAL

27.5" X 2.6 Re

KR
KRYPTOTAL

27.5" X 2.4

AR
ARGOTAL

27.5" X 2.6

AR
ARGOTAL

29" X 2.4

AR
ARGOTAL

29" X 2.6

AR
ARGOTAL

27.5" X 2.4

AR
ARGOTAL

27.5" X 2.6

AR
ARGOTAL



TERRAIN



HARDPACK



MIXED



LOOSE



MUD

COMPOUND



SUPER SOFT

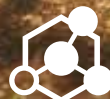

SOFT



ENDURANCE

INFINITE POSSIBILITIES

Gravity Range



G



**DOWNHILL
SOFT**



**DOWNHILL
SUPER SOFT**

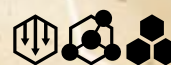

27.5" X 2.4

29" X 2.4

27.5" X 2.4

29" X 2.4

XY
XYNOTAL

XY
XYNOTAL

XY
XYNOTAL

XY
XYNOTAL

27.5" X 2.4

Fr

29" X 2.4

Fr

KR
KRYPTOTAL

KR
KRYPTOTAL

29" X 2.4

Re

29" X 2.6

Re

KR
KRYPTOTAL

KR
KRYPTOTAL

27.5" X 2.4

Re

29" X 2.4

Re

KR
KRYPTOTAL

KR
KRYPTOTAL

27.5" X 2.4

Re

29" X 2.4

Re

KR
KRYPTOTAL

KR
KRYPTOTAL

29" X 2.4

29" X 2.6

AR
ARGOTAL

AR
ARGOTAL

27.5" X 2.4

29" X 2.4

AR
ARGOTAL

AR
ARGOTAL

27.5" X 2.4

29" X 2.4

AR
ARGOTAL

AR
ARGOTAL

27.5" X 2.4

29" X 2.4

HY
HYDROTAL

HY
HYDROTAL

RIDING



DOWNHILL



ENDURO



TRAIL

CASING



DOWNHILL



ENDURO



TRAIL



NOVELTY

Xynotal CONTROL OVER ROCK AND HARDPACK TERRAIN

Perfect for hardpack, rocky surfaces. With low rolling resistance and defined contact edges for improved traction and braking, you can go full gas knowing you'll have consistent grip right when you need it the most.



HARDPACK

TR E25



Xynotal						NEW	
Article	ETRTO	Dimension	Color/sidewall	g	PSI	RRP/€	
Downhill SuperSoft - 6/660 TPI							
0101931	60-584	27.5 x 2.40	● foldable	1255	36-51	84,99	
0101932	60-622	29 x 2.40	● foldable	1335	36-51	84,99	
Downhill Soft - 6/660 TPI							
0101995	60-584	27.5 x 2.40	● foldable	1260	36-51	79,99	
0101996	60-622	29 x 2.40	● foldable	1335	36-51	79,99	
Enduro Soft - 3/330 TPI							
0101997	60-584	27.5 x 2.40	● foldable	1115	36-51	69,99	
0101998	60-622	29 x 2.40	● foldable	1180	36-51	69,99	
Trail Endurance - 3/180 TPI							
0150646	60-584	27.5 x 2.40	● foldable	1000	36-51	59,99	
0150647	60-622	29 x 2.40	● foldable	1060	36-51	59,99	

NOVELTY

Kryptotal **SPECIALISTS FOR MIXED TERRAIN**

Optimized for front wheels, this all-round tire achieves the perfect balance of stability, traction and optimal rolling resistance. Ideal for mixed terrain, they'll allow you to push your limits during trail, enduro and downhill riding.



MIXED

**Kryptotal Fr****NEW**

Downhill SuperSoft - 6/660 TPI

**E25 TR**

Article	ETRTO	Dimension	Color/sidewall	g	PSI	RRP/€
0101956	60-584	27.5 x 2.40	● foldable	1255	36-51	84,99
0101957	60-622	29 x 2.40	● foldable	1335	36-51	84,99
Enduro Soft - 3/330 TPI						
0102003	60-584	27.5 x 2.40	● foldable	1115	36-51	69,99
0102004	60-622	29 x 2.40	● foldable	1180	36-51	69,99
Trail Endurance - 3/180 TPI						
0150695	60-584	27.5 x 2.40	● foldable	1000	36-51	59,99
0150697	60-622	29 x 2.40	● foldable	1060	36-51	59,99



NOVELTY

Kryptotal ^{Re}

SPECIALISTS FOR MIXED TERRAIN

Optimized for rear wheels, this all-round tire achieves the perfect balance of stability, traction and optimal rolling resistance. Ideal for mixed terrain, they'll allow you to push your limits during trail, enduro and downhill riding.



MIXED



Kryptotal Re						NEW	
Downhill SuperSoft - 6/660 TPI							
Article	ETRTO	Dimension	Color/sidewall	g	PSI	RRP/€	TR
0101928	60-584	27.5 x 2.40	● foldable	1255	36-51	84,99	
0101930	60-622	29 x 2.40	● foldable	1335	36-51	84,99	
Downhill Soft - 6/660 TPI							
0101991	60-584	27.5 x 2.40	● foldable	1260	36-51	79,99	
0101992	60-622	29 x 2.40	● foldable	1335	36-51	79,99	
Enduro Soft - 3/330 TPI							
0101993	60-584	27.5 x 2.40	● foldable	1115	36-51	69,99	
0101994	60-622	29 x 2.40	● foldable	1180	36-51	69,99	
0150635	65-584	27.5 x 2.60	● foldable	1265	29-44	74,99	
0150636	65-622	29 x 2.60	● foldable	1345	29-44	74,99	
Trail Endurance - 3/180 TPI							
0150637	60-584	27.5 x 2.40	● foldable	1000	36-51	59,99	
0150638	60-622	29 x 2.40	● foldable	1060	36-51	59,99	
0150639	65-584	27.5 x 2.60	● foldable	1155	29-44	64,99	
0150640	65-622	29 x 2.60	● foldable	1240	29-44	64,99	

NOVELTY

Argotal















ENGINEERED FOR LOOSE CONDITIONS

The ideal tire for loose terrain given its incredible cornering stability and enhanced side-grip. The open tread pattern allows for self-cleaning so you can push your limits while riding through dust and loam.



LOOSE



Argotal						NEW	
Downhill SuperSoft - 6/660 TPI						    	
Article	ETRTO	Dimension	Color/sidewall	g	PSI	RRP/€	
0101951	60-584	27.5 x 2.40	● foldable	1255	36-51	84,99	
0101953	60-622	29 x 2.40	● foldable	1335	36-51	84,99	
Downhill Soft - 6/660 TPI						  	
0101999	60-584	27.5 x 2.40	● foldable	1260	36-51	79,99	
0102000	60-622	29 x 2.40	● foldable	1335	36-51	79,99	
Enduro Soft - 3/330 TPI						  	
0102001	60-584	27.5 x 2.40	● foldable	1115	36-51	69,99	
0102002	60-622	29 x 2.40	● foldable	1180	36-51	69,99	
0150685	65-584	27.5 x 2.60	● foldable	1265	29-44	74,99	
0150688	65-622	29 x 2.60	● foldable	1345	29-44	74,99	
Trail Endurance - 3/180 TPI						  	
0150689	60-584	27.5 x 2.40	● foldable	1000	36-51	59,99	
0150691	60-622	29 x 2.40	● foldable	1060	36-51	59,99	
0150690	65-584	27.5 x 2.40	● foldable	1155	29-44	64,99	
0150692	65-622	29 x 2.60	● foldable	1240	29-44	64,99	

NOVELTY



Hydrotal

DOMINATES THE WET AND MUD

Our specialist tire for downhill riding which also provides a super-soft compound option for racing. Hydrotal balances grip and rolling resistance and features a self-cleaning tread to ensure consistent grip when you're shredding through muddy, slippery conditions.



MUD

TR E25



Hydrotal

NEW

Downhill SuperSoft - 6/660 TPI



E25 TR

Article	ETRTO	Dimension	Color/sidewall	g	PSI	RRP/€
0101954	60-584	27.5 x 2.40	● foldable	1255	36-51	84,95
0101955	60-622	29 x 2.40	● foldable	1335	36-51	84,95



Mountain King FOR SAFE OFF-ROADING

The perfect trail ride companion - not stingy on grip, ideal for full-suspension trail bikes. The snappy central knobs and grippy outer knobs means it offers maximum grip.



Mountain King							E25	TR
BlackChili Compound - ProTectiOn - 3/180 TPI							E25	TR
Article	ETRTO	Dimension	Color/sidewall	g	PSI	RRP/€		
0101479	58-559	26 x 2.30	● foldable	610	40-54	59,99		
0101461	58-584	27.5 x 2.30	● foldable	640	40-54	59,99		
0101583	65-584	27.5 x 2.60	● foldable	790	29-44	65,99		
0101582	70-584	27.5 x 2.80	● foldable	830	25-40	65,99		
0101469	58-622	29 x 2.30	● foldable	680	40-54	59,99		
PureGrip Compound - ShieldWall System - 3/180 TPI							E25	TR
0150301	58-559	26 x 2.30	● foldable	765	40-54	35,99		
0150289	58-584	27.5 x 2.30	● foldable	770	40-54	35,99		
0150335	65-584	27.5 x 2.60	● foldable	935	29-44	40,99		
0150334	70-584	27.5 x 2.80	● foldable	1020	25-40	40,99		
0150294	58-622	29 x 2.30	● foldable	815	40-54	35,99		
Wire - 3/180 TPI							E25	
0150425	58-584	27.5 x 2.30	● Wire	765	40-54	23,99		
0150427	58-622	29 x 2.30	● Wire	810	40-54	23,99		



Cross King | Cross King Bernstein Edition

THE ALL-ROUNDER

Versatile competition and trail tire, sure footed in turns and comfortable. Good grip and available with various technologies. Smoothly rolling tire that adapts to any terrain with its special tread.



Cross King							E25	TR
BlackChili Compound - ProTecton - 3/180 TPI							E25	TR
Article	ETRTO	Dimension	Color/sidewall	g	PSI	RRP/€		
0101964	55-559	26 x 2.20	● foldable	610	45-58	59,99		
0101483	55-559	26 x 2.20	● foldable	570	45-58	59,99		
0101481	58-559	26 x 2.30	● foldable	610	40-54	59,99		
0101965	55-584	27.5 x 2.20	● foldable	640	45-58	59,99		
0101465	55-584	27.5 x 2.20	● foldable	595	45-58	59,99		
0101463	58-584	27.5 x 2.30	● foldable	640	40-54	59,99		
0101384	65-584	27.5 x 2.60	● foldable	790	29-44	65,99		
0101385	70-584	27.5 x 2.80	● foldable	830	25-40	65,99		
0101966	55-622	29 x 2.20	● foldable	675	45-58	59,99		
0101471	55-622	29 x 2.20	● foldable	635	45-58	59,99		
0101475	58-622	29 x 2.30	● foldable	680	40-54	59,99		
PureGrip Compound - ShieldWall System - 3/180 TPI							E25	TR
0150310	50-559	26 x 2.00	● foldable	630	51-65	35,99		
0150303	55-559	26 x 2.20	● foldable	720	45-58	35,99		
0150302	58-559	26 x 2.30	● foldable	765	40-54	35,99		
0150308	50-584	27.5 x 2.00	● foldable	665	51-65	35,99		
0150291	55-584	27.5 x 2.20	● foldable	740	45-58	35,99		
0150290	58-584	27.5 x 2.30	● foldable	780	40-54	35,99		
0150337	65-584	27.5 x 2.60	● foldable	920	29-44	40,99		
0150336	70-584	27.5 x 2.80	● foldable	1040	25-40	40,99		
0150306	50-622	29 x 2.00	● foldable	705	51-65	35,99		
0150295	55-622	29 x 2.20	● foldable	785	45-58	35,99		
0150297	58-622	29 x 2.30	● foldable	825	40-54	35,99		
0150502	65-622	29 x 2.60	● foldable	995	29-44	40,99		
Wire - 3/180 TPI							E25	
0150407	58-559	26 x 2.30	● Wire	760	40-54	23,99		
0150408	58-584	27.5 x 2.30	● Wire	775	40-54	23,99		
0150406	55-622	29 x 2.20	● Wire	785	45-58	23,99		
0150410	58-622	29 x 2.30	● Wire	820	40-54	23,99		



Race King | Race King Bernstein Edition

FIRST CHOICE FOR RACERS

Classic competition tire which feels at home at the Cross Country World Cup or at marathons. Low rolling resistance, good self-damping and low weight make it the right choice for all race bikes.



Race King

BlackChili Compound - ProTecton - 3/180 TPI

E25 **TR**

Article	ETRTO	Dimension	Color/sidewall	g	PSI	RRP/€
0101961	55-559	26 x 2.20	● foldable	555	45-58	59,99
0101486	55-559	26 x 2.20	● foldable	540	45-58	59,99
0101962	55-584	27.5 x 2.20	● foldable	580	45-58	59,99
0101467	55-584	27.5 x 2.20	● foldable	570	45-58	59,99
0101963	55-622	29 x 2.20	● foldable	615	45-58	59,99
0101473	55-622	29 x 2.20	● foldable	605	45-58	59,99

PureGrip Compound - ShieldWall System - 3/180 TPI

E25 **TR**

0150311	50-559	26 x 2.00	● foldable	585	51-65	35,99
0150309	50-584	27.5 x 2.00	● foldable	625	51-65	35,99
0150292	55-584	27.5 x 2.20	● foldable	695	45-58	35,99
0150307	50-622	29 x 2.00	● foldable	660	51-65	35,99
0150296	55-622	29 x 2.20	● foldable	740	45-58	35,99

Wire - 3/180 TPI

E25

0150433	55-584	27.5 x 2.20	● Wire	705	45-58	23,99
0150435	55-622	29 x 2.20	● Wire	750	45-58	23,99



Ruban FROM RURAL TO URBAN

The energy-saving SUV allrounder that gets you to both Rural and Urban.
The partner for your commute, running errands and the weekend tour.



Ruban							
PureGrip Compound - ShieldWall System - 3/180 TPI						E25	TR
Article	ETRTO	Dimension	Color/sidewall	g	PSI	RRP/€	
0150574	54-584	27.5 x 2.10	● foldable	650	45-58	35,99	
0150575	58-584	27.5 x 2.30	● foldable	795	40-54	35,99	
0150576	65-584	27.5 x 2.60	● foldable	865	29-44	40,99	
0150577	54-622	29 x 2.10	● foldable	695	45-58	35,99	
0150578	58-622	29 x 2.30	● foldable	845	40-54	35,99	
0150579	65-622	29 x 2.60	● foldable	910	29-44	40,99	
Wire - 3/180 TPI						E25	
0150537	58-584	27.5 x 2.30	● Wire refl.	805	40-54	30,99	
0150539	65-584	27.5 x 2.60	● Wire refl.	865	29-44	35,99	
0150541	54-622	29 x 2.10	● Wire refl.	705	45-58	30,99	
0150545	58-622	29 x 2.30	● Wire	840	40-54	28,99	
0150546	58-622	29 x 2.30	● Wire refl.	850	40-54	30,99	



Specifically designed for the
use on electrified bikes



eRuban Plus FROM RURAL TO URBAN

The energy-saving SUV allrounder that gets you to both Rural and Urban.
The partner for your commute, running errands and the weekend tour.



eRuban Plus

PureGrip Compound - PolyX Breaker™ - Plus Breaker - Wire - 3/180 TPI

E50

Article	ETRTO	Dimension	Color/sidewall	g	PSI	RRP/€
0150550	58-559	26 x 2.30	● Wire	805	40-54	35,99
0150555	58-559	26 x 2.30	● Wire refl.	810	40-54	37,99

ROAD



[instagram.com/conti_road](https://www.instagram.com/conti_road)





Grand Prix 5000 S TR THE NEW ERA IN CYCLING

The new Grand Prix 5000 S Tubeless Ready: Lighter, faster and with stronger sidewalls. The new standard in road tubeless ready technology. Ride faster, more comfortable and with increased puncture protection. Made to make you better.

- ! For initial mounting we recommend to use at least 30 ml of Conti RevoSealant per tire. Then spin the tire (wheel) to spread the Conti RevoSealant inside of the tire and pump to the allowed maximum pressure. Check the pressure before the next ride and adjust to your desired PSI.

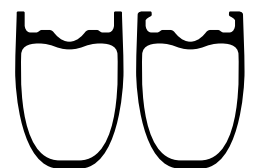

Grand Prix 5000 S TR							Recommended		
BlackChili Compound - Vectran Breaker - LazerGrip - 2/220 TPI						TR	hookless	hooked	
Article	ETRTO	Dimension	Color/sidewall	g	PSI	RRP/€	max. Rim width	max. PSI	max. PSI
0101934	30-584	650 x 30B	● foldable	305	56-70	87,99	25TSS/C	73	73
0101935	32-584	650 x 32B	● foldable	330	51-73	87,99	25TSS/C	73	73
0101866	25-622	700 x 25C	● foldable	275	73-109	87,99	21TSS/C	73	109
0101873	25-622	700 x 25C	● foldable	280	73-109	87,99	21TSS/C	73	109
0101867	28-622	700 x 28C	● foldable	305	73-94	87,99	25TSS/C	73	95
0101874	28-622	700 x 28C	● foldable	305	73-94	87,99	25TSS/C	73	95
0101868	30-622	700 x 30C	● foldable	325	56-70	87,99	25TSS/C	73	73
0101875	30-622	700 x 30C	● foldable	330	56-70	87,99	25TSS/C	73	73
0101869	32-622	700 x 32C	● foldable	350	51-73	87,99	25TSS/C	73	73
0101876	32-622	700 x 32C	● foldable	350	51-73	87,99	25TSS/C	73	73



Grand Prix 5000 THE NEW ERA IN CYCLING

Ride faster, more comfortable, and with increased puncture protection. Made to make you better. If your aim is a tubeless approach, we've got you covered as well.



Grand Prix 5000

BlackChili Compound - Vectran Breaker - LazerGrip - ACT - 3/330 TPI

Article	ETRTO	Dimension	Color/sidewall	g	PSI	RRP/€
0101620	25-584	650 x 25B	● foldable	210	95-120	70,99
0101622	28-584	650 x 28B	● foldable	230	95-115	70,99
0101623	23-622	700 x 23C	● foldable	200	110-120	70,99
0101624	25-622	700 x 25C	● foldable	225	95-120	70,99
0101947	25-622	700 x 25C	● foldable	260	95-120	70,99
0101895	25-622	700 x 25C	● foldable	230	95-120	70,99
0101625	28-622	700 x 28C	● foldable	240	95-115	70,99
0101948	28-622	700 x 28C	● foldable	290	95-115	70,99
0101896	28-622	700 x 28C	● foldable	245	95-115	70,99
0101626	32-622	700 x 32C	● foldable	285	85-102	70,99
BlackChili Compound - Vectran Breaker - LazerGrip - ACT - 3/330 TPI						E50
0101813	30-622	700 x 30C	● foldable	255	85-102	70,99



Grand Prix

A COMFORTABLE ALL-ROUNDER THAT HAS BEEN WRITTEN INTO CYCLING HISTORY

A reliable all-round tire with solid construction, made for sportive tours in demanding terrain. Made to last for many miles. Available in many sizes.



Grand Prix

BlackChili Compound - PolyX Breaker - 3/180 TPI

Article	ETRTO	Dimension	Color/sidewall	g	PSI	RRP/€
0100149	28-559	26 x 1 1/8	● foldable	245	95-115	42,99
0100148	28-559	26 x 1 1/8	● Wire	305	95-115	37,99
0100502	23-571	650 x 23C	● Wire	275	110-120	37,99
0100506	23-622	700 x 23C	● foldable	230	110-120	42,99
0100505	23-622	700 x 23C	● Wire	300	110-120	37,99
0100637	25-622	700 x 25C	● foldable	230	110-120	42,99
0101109	28-622	700 x 28C	● foldable	270	95-115	42,99
0100157	28-622	700 x 28C	● Wire	335	95-115	37,99



Grand Prix 4-Season

THE ALL-YEAR-ROUND TIRE AND A RELIABLE COMPANION FOR THOSE HIGH MILEAGE ROAD CYCLISTS

Reliable companion for training rides and in competition, come rain or shine. The tire with a superior durability ready for any season. With DuraSkin® sidewall reinforcement.

Vectran™
BREAKER

DuraSkin®

Grand Prix 4-Season

Double Vectran Breaker - 3/330 TPI

Article	ETRTO	Dimension	Color/sidewall	g	PSI	RRP/€
0100173	23-622	700 x 23C	● foldable	235	110-120	65,99
0100175	25-622	700 x 25C	● foldable	230	95-120	65,99
0101105	28-622	700 x 28C	● foldable	295	95-115	65,99
0101095	32-622	700 x 32C	● foldable	340	85-102	65,99



Grand Prix Classic

TECHNOLOGY OF TODAY COMBINED WITH AN OLD CLASSIC

The perfect match for the retro styled racing bike. Features with brown sidewalls and the original Conti Sport tread pattern from 1982.



Grand Prix Classic

BlackChili Compound - PolyX Breaker - 3/180 TPI

Article	ETRTO	Dimension	Color/sidewall	g	PSI	RRP/€
0199295	25-622	700 x 25C	● foldable	225	95-120	42,99



Ultra Sport III

MODERN TIRE FOR THOSE NEW TO ROAD CYCLING

Completely renewed, sporting a dynamic tread pattern design. Matches with a race bike, as well as a classic city road bike. Available in a wide range of dimensions and colors.



Ultra Sport III

PureGrip Compound - 3/180 TPI

E25

Article	ETRTO	Dimension	Color/sidewall	g	PSI	RRP/€
0150472	25-584	650 x 25B	● foldable	250	95-120	27,99
0150475	28-584	650 x 28B	● foldable	275	95-115	27,99
0150449	23-622	700 x 23C	● foldable	245	110-120	27,99
0150457	25-622	700 x 25C	● foldable	265	95-120	27,99
0150466	28-622	700 x 28C	● foldable	295	80-115	27,99
0150680	28-622	700 x 28C	● foldable	285	80-115	27,99



Gatorskin

**RIDE HOW AND WHERE YOU WANT:
THE GLOBAL NUMBER ONE FOR FIXED,
MESSENGER AND URBAN CYCLISTS**

The right tire when it comes to tough conditions. The right choice for a strong performance in the urban field and on tour. With DuraSkin® sidewall reinforcement (comes in black with our Black Edition).



Gatorskin						
PolyX Breaker - 3/180 TPI						
Article	ETRTO	Dimension	Color/sidewall	g	PSI	RRP/€
0118365	28-559	26 x 1 1/8	● Wire	320	95-120	42,99
0118364	23-571	650 x 23C	● Wire	275	110-120	42,99
0118538	23-622	700 x 23C	● foldable	230	110-120	49,99
0118537	23-622	700 x 23C	● Wire	300	110-120	42,99
0100084	25-622	700 x 25C	● foldable	245	95-120	49,99
0100641	28-622	700 x 28C	● foldable	280	95-115	49,99
0100642	32-622	700 x 32C	● foldable	350	85-102	49,99
0122300	32-630	27 x 1 1/4	● Wire	420	85-102	42,99



Gatorskin Black Edition						
PolyX Breaker - 3/180 TPI						
Article	ETRTO	Dimension	Color/sidewall	g	PSI	RRP/€
0101728	23-622	700 x 23C	● foldable	230	110-120	49,99
0101729	25-622	700 x 25C	● foldable	245	95-120	49,99
0101730	28-622	700 x 28C	● foldable	280	95-115	49,99
0101731	32-622	700 x 32C	● foldable	350	85-102	49,99



Gator Hardshell

GO HARDSHELL OR GO HOME

Ideal when it comes to extremely long service life, for the next tour or the commute. Made for rough surfaces and rugged tarmac. With DuraSkin® sidewall reinforcement (comes in black with our Black Edition).



Gator Hardshell

Hardshell - 3/180 TPI

Article	ETRTO	Dimension	Color/sidewall	g	PSI	RRP/€
0100311	23-622	700 x 23C	● foldable	265	110-120	54,99
0100310	23-622	700 x 23C	● Wire	335	110-120	49,99
0100313	25-622	700 x 25C	● foldable	270	95-120	54,99
0100312	25-622	700 x 25C	● Wire	340	95-120	49,99
0100639	28-622	700 x 28C	● foldable	330	95-115	54,99
0100314	28-622	700 x 28C	● Wire	400	95-115	49,99
0100640	32-622	700 x 32C	● foldable	370	85-102	54,99
0100435	32-622	700 x 32C	● Wire	440	85-102	49,99
0100315	32-630	27 x 1¼	● Wire	440	85-102	49,99



Gator Hardshell Black Edition

Hardshell - 3/180 TPI

Article	ETRTO	Dimension	Color/sidewall	g	PSI	RRP/€
0101724	23-622	700 x 23C	● foldable	265	110-120	54,99
0101725	25-622	700 x 25C	● foldable	270	95-120	54,99
0101726	28-622	700 x 28C	● foldable	330	95-115	54,99
0101727	32-622	700 x 32C	● foldable	370	85-102	54,99



Grand Sport Race

PROVEN RACING TIRE CONTOUR FOR RESPONSIVE HANDLING AND SECURE GRIP

Performance in touring and competition. This all-rounder is ready for every challenge, even the biggest ones.



Grand Sport Race

PureGrip Compound - NyTech Breaker - 3/180 TPI

Article	ETRTO	Dimension	Color/sidewall	g	PSI	RRP/€
0150001	23-622	700 X 23C	● foldable	245	110-120	37,99
0150027	25-622	700 X 25C	● foldable	270	95-120	37,99
0150025	25-622	700 X 25C	● Wire	345	95-120	32,99
0150118	28-622	700 X 28C	● foldable	335	80-115	37,99
0150116	28-622	700 X 28C	● Wire	410	80-115	32,99
0150624	28-622	700 X 28C	● foldable	305	80-115	37,99
0150141	32-622	700 X 32C	● foldable	400	65-102	37,99



Hometrainer II

THE KM ACCUMULATOR ON THE ROLLERS

Developed for the essential basic training at home. Particularly smooth running. The durable cold-running compound stops heat build up.

! Suitable for training on rollers/home trainers only.

Hometrainer II

Foldable - 3/180 TPI

Article	ETRTO	Dimension	Color/sidewall	g	PSI	RRP/€
0100648	47-559	26 x 1.75	● foldable	365	45-65	36,99
0101275	50-584	27.5 x 2.00	● foldable	400	45-65	36,99
0100647	23-622	700 x 23C	● foldable	205	110-120	36,99
0100649	32-622	700 x 25C	● foldable	275	85-102	36,99

GRAVEL



[instagram.com/conti_road](https://www.instagram.com/conti_road)



Terra Speed

CHOOSE ALTER ROAD, CHOOSE TERRA

For your way off-road. For more comfort. For the adventure. Be it the long tour, or the shortcut on your way home. Made to get you over rough and smooth.



Terra Speed

ProTecton - 3/180 TPI

E25 TR

Article	ETRTO	Dimension	Color/sidewall	g	PSI	RRP/€
0101719	35-584	650 X 35B	● foldable	400	45-73	63,99
0101720	35-584	650 X 35B	● foldable	400	45-73	63,99
0101717	40-584	650 X 40B	● foldable	440	45-73	63,99
0101718	40-584	650 X 40B	● foldable	440	45-73	63,99
0101693	35-622	700 X 35C	● foldable	420	45-73	63,99
0101700	35-622	700 X 35C	● foldable	415	45-73	63,99
0101694	40-622	700 X 40C	● foldable	460	45-73	63,99
0101702	40-622	700 X 40C	● foldable	455	45-73	63,99
0101837	40-622	700 X 40C	● foldable	495	45-73	63,99
0102007	45-622	700 X 45C	● foldable	490	45-65	63,99

STREET

OFFROAD / BIKEPACKING



Terra Trail

CHOOSE ALTER ROAD, CHOOSE TERRA

For your way off-road. For more comfort. For the adventure. Be it the long tour, or the shortcut on your way home. Made to get you over rough and smooth.



Terra Trail

ProTction - 3/180 TPI

E25 TR

Article	ETRTO	Dimension	Color/sidewall	g	PSI	RRP/€
0101715	40-584	650 X 40B	● foldable	435	45-73	63,99
0101716	40-584	650 X 40B	● foldable	435	45-73	63,99
0101944	40-584	650 X 40B	● foldable	470	45-73	63,99
0101697	40-622	700 X 40C	● foldable	455	45-73	63,99
0101701	40-622	700 X 40C	● foldable	455	45-73	63,99
0101836	40-622	700 X 40C	● foldable	490	45-73	63,99

PureGrip Compound - ShieldWall System - 3/180 TPI

E25 TR

0150509	47-584	650 X 47B	● foldable	520	36-65	39,99
0150508	47-584	650 X 47B	● foldable	525	36-65	39,99
0150503	35-622	700 X 35C	● foldable	425	45-73	39,99
0150505	35-622	700 X 35C	● foldable	440	45-73	39,99
0150507	40-622	700 X 40C	● foldable	495	45-73	39,99
0150673	40-622	700 X 40C	● foldable	475	45-73	39,99
0150675	45-622	700 X 45C	● foldable	535	36-65	39,99
0150674	45-622	700 X 45C	● foldable	475	36-65	39,99

STREET

OFFROAD / BIKEPACKING

NOVELTY



Terra Hardpack

CHOOSE ALTER ROAD, CHOOSE TERRA

For your way off-road. For more comfort. For the adventure. Be it the long tour, or the shortcut on your way home. Made to get you over rough and smooth.



Terra Hardpack

NEW

PureGrip Compound - ShieldWall System - 3/180 TPI

TR

Article	ETRTO	Dimension	Color/sidewall	g	PSI	RRP/€
0150563	50-584	650 X 50B	● foldable	575	51-65	39,99
0150565	50-622	700 X 50C	● foldable	615	51-65	39,99

STREET

OFFROAD / BIKEPACKING

URBAN TOUR



[instagram.com/conti_urban](https://www.instagram.com/conti_urban)



Specifically designed for the use on electrified bikes

NOVELTY





eCONTACT Plus THE ULTIMATE IN CONFIDENCE AND COMFORT

The eCONTACT Plus is a tire specifically developed for the commuting and load-carrying demands of e-bikes. Equipped with E50 certification, durability and puncture protection are enhanced to resist the stresses from increased torque and acceleration. This high-mileage tire features a compact tread pattern to keep rolling resistance low, boosting the range of each battery charge.

Not only is the eCONTACT Plus strengthened against small objects such as glass and thorns, but thanks to the unique tread and advancement of the Continental construction technologies, it also boasts better protection from nails and larger hazards.

Safety + Pro 

eCONTACT Plus							NEW
SafetyPlus Pro Breaker - 3/180 TPI - 							E50 
Article	ETRTO	Dimension	Color/sidewall	g	PSI	kg+	RRP/€
0101973	50-406	20 x 2.00	● Wire refl.	745	50-73	85	47,99
0101974	55-406	20 x 2.20	● Wire refl.	770	45-73	90	47,99
0101975	62-406	20 x 2.50	● Wire refl.	835	45-58	115	47,99
0101976	55-559	26 x 2.00	● Wire refl.	1100	36-65	128	47,99
0101977	55-584	27.5 x 2.20	● Wire refl.	1195	36-65	128	47,99
0101978	62-584	27.5 x 2.50	● Wire refl.	1220	36-65	128	47,99
0101979	50-622	28 x 2.00	● Wire refl.	1095	45-73	121	47,99
0101980	55-622	28 x 2.20	● Wire refl.	1150	36-65	128	47,99
0101981	62-622	28 x 2.50	● Wire refl.	1270	36-58	128	47,99

SAFETY LEVEL





CONTACT Plus
ALL YOU WOULD EXPECT FROM
A COMFORTABLE TIRE

An allrounder on any type of roads and paths that enhances every bike. Thanks to the plus in puncture protection, nobody will be left behind with a flat tire.

ECE-R75-certified, designated for usage on e-bikes up to 50km/h.



CONTACT Plus							
SafetyPlus Breaker - 3/180 TPI -							
Article	ETRTO	Dimension	Color/sidewall	g	PSI	kg+	RRP/€
0101002	47-559	26 x 1.75	● Wire refl.	1040	45-58	109	42,99
0101005	37-622	28 x 1 1/8 x 1 1/8	● Wire refl.	980	58-85	100	42,99
0101006	42-622	28 x 1.60	● Wire refl.	1050	51-73	100	42,99
0101007	47-622	28 x 1.75	● Wire refl.	1150	45-58	95	42,99
0101008	42-635	28 x 1 1/2	● Wire refl.	1070	51-65	100	42,99

E50

SAFETY LEVEL							
---------------------	--	--	--	--	--	--	--



CONTACT Plus City OUT AND ABOUT IN TOWN

Exactly the right tire to explore the city securely and relaxed thanks to a tread pattern made for tarmac, efficient rolling characteristics, and a maximum of puncture protection. With its ECE-R75-certification, cyclists can ride economically and save energy even on e-bikes up to 50km/h.



CONTACT Plus City

SafetyPlus Breaker - 3/180 TPI -

E50

Article	ETRTO	Dimension	Color/sidewall	g	PSI	kg+	RRP/€
0101331	47-559	26 x 1.75	● Wire refl.	1000	45-58	109	42,99
0101335	55-584	27.5 x 2.20	● Wire refl.	1270	45-58	128	42,99
0101336	37-622	28 x 1 $\frac{1}{8}$ x 1 $\frac{1}{8}$	● Wire refl.	900	58-85	95	42,99
0101340	42-622	28 x 1.60	● Wire refl.	990	51-73	100	42,99
0101343	47-622	28 x 1.75	● Wire refl.	1130	45-58	95	42,99

SAFETY LEVEL





CONTACT WHEN THINGS GET TOUGH

Versatile allrounder which connects reliably to every surface. Equipped with the most popular tread pattern from the urban/tour range, especially designed for a high degree of safety thanks to its lamellar structure.

Safety  System 

CONTACT

SafetySystem Breaker - 3/180 TPI

E25 

Article	ETRTO	Dimension	Color/sidewall	g	PSI	RRP/€
0101310	37-406	20 x 1.40	● Wire	420	56-70	17,99
0101315	47-559	26 x 1.75	● Wire refl.	670	45-58	31,99
0101314	47-559	26 x 1.75	● Wire	670	45-58	29,99
0101316	28-622	28 x 1 $\frac{1}{4}$ x 1 $\frac{1}{4}$	● Wire	480	80-102	29,99
0101318	32-622	28 x 1 $\frac{1}{4}$ x 1 $\frac{1}{4}$	● Wire	495	70-85	29,99
0101320	37-622	28 x 1 $\frac{1}{8}$ x 1 $\frac{1}{8}$	● Wire refl.	610	58-85	31,99
0101321	37-622	28 x 1 $\frac{1}{8}$ x 1 $\frac{1}{8}$	● Wire	610	58-85	29,99
0101324	42-622	28 x 1.60	● Wire refl.	645	51-85	31,99
0101325	42-622	28 x 1.60	● Wire	645	51-85	29,99
0101328	47-622	28 x 1.75	● Wire refl.	770	45-58	31,99
0101327	47-622	28 x 1.75	● Wire	770	45-58	29,99

SAFETY LEVEL





CONTACT Urban CYCLING ON THE CITY PULSE

Premium mobility for design enthusiasts. Urban tread pattern packed with the latest technology. The perfect symbiosis between light-rolling and puncture protection reflected in this specialized tire designed for the city jungle.

Faster? Not a problem with approval for e-bikes up to 50km/h.

PURE GRIP
COMPOUND

Safety System

E50

CONTACT Urban

PureGrip Compound - SafetyPro - 3/180 TPI

E50 6

Article	ETRTO	Dimension	Color/sidewall	g	PSI	kg+	RRP/€
0150567	35-349	16 x 1.35	● Wire refl.	265	65-116	65	32,99
0150365	32-406	20 x 1.25	● Wire refl.	295	65-102	71	32,99
0150352	42-406	20 x 1.60	● Wire refl.	355	58-85	75	32,99
0150354	50-406	20 x 2.00	● Wire refl.	430	51-73	80	32,99
0150366	47-559	26 x 1.75	● Wire refl.	565	45-73	112	32,99
0150355	50-559	26 x 2.00	● Wire refl.	590	51-73	121	32,99
0150367	55-559	26 x 2.20	● Wire refl.	665	36-65	132	32,99
0150353	42-584	27.5 x 1.60	● Wire refl.	515	58-94	106	32,99
0150357	50-584	27.5 x 2.00	● Wire refl.	615	58-94	121	32,99
0150368	55-584	27.5 x 2.20	● Wire refl.	690	36-65	132	32,99
0150658	62-584	27.5 x 2.50	● Wire refl.	750	45-58	132	32,99
0150369	28-622	28 x 1 1/4 x 1 1/4	● Wire refl.	400	80-109	85	32,99
0150370	32-622	28 x 1 1/4 x 1 1/4	● Wire refl.	445	65-94	90	32,99
0150371	35-622	28 x 1 1/4 x 1 1/4	● Wire refl.	465	65-94	95	32,99
0150350	37-622	28 x 1 1/4 x 1 1/4	● Wire refl.	485	58-94	100	32,99
0150351	40-622	28 x 1.50	● Wire refl.	545	58-94	100	32,99
0150349	42-622	28 x 1.60	● Wire refl.	545	51-85	106	32,99
0150372	47-622	28 x 1.75	● Wire refl.	625	45-73	115	32,99
0150358	50-622	28 x 2.00	● Wire refl.	655	51-73	121	32,99
0150373	55-622	28 x 2.20	● Wire refl.	735	36-65	132	32,99
0150656	62-622	28 x 2.50	● Wire refl.	795	45-58	132	32,99

SAFETY LEVEL





CONTACT Speed UNITES SPEED AND COMFORT IN ONE TIRE

The perfect choice for the city speedsters, single-speed bikes and fitness bikes. With its double layer of fabric breaker, the light-weight design and its roughened slick tread it shines especially on tarmac.

Safety  System 

CONTACT Speed

SafetySystem Breaker - 3/180 TPI

E25 

Article	ETRTO	Dimension	Color/sidewall	g	PSI	RRP/€
0101387	28-406	20 x 1.10	● Wire	265	70-85	17,99
0101391	32-559	26 x 1.30	● Wire refl.	430	70-85	31,99
0101389	32-559	26 x 1.30	● Wire	430	70-85	29,99
0101392	42-559	26 x 1.60	● Wire refl.	540	65-85	31,99
0101393	42-559	26 x 1.60	● Wire	540	65-85	29,99
0101396	50-559	26 x 2.00	● Wire refl.	665	45-58	31,99
0101395	50-559	26 x 2.00	● Wire	665	45-58	29,99
0101397	32-584	27.5 x 1.25	● Wire	470	70-85	29,99
0101401	50-584	27.5 x 2.00	● Wire	700	51-65	29,99
0101402	28-622	28 x 1½ x 1½	● Wire	425	80-102	29,99
0101408	32-622	28 x 1¼ x 1¼	● Wire refl.	485	70-85	31,99
0101406	32-622	28 x 1¼ x 1¼	● Wire	485	70-85	29,99
0101414	37-622	28 x 1½ x 1½	● Wire refl.	500	70-85	31,99
0101412	37-622	28 x 1½ x 1½	● Wire	500	70-85	29,99
0101416	42-622	28 x 1.60	● Wire	590	51-85	29,99

SAFETY LEVEL





CONTACT Spike 120 und 240

OUR RECOMMENDATION FOR SNOW AND ICY ROADS

Safety during cold and dark seasons: The spikes guarantee traction, the reflective stripes ensure visibility. Maintain full control of your bicycle even in turns and hard stops. Choose between 120 or 240 spikes.

Safety  System 

CONTACT Spike 120

SafetySystem Breaker - 3/180 TPI

E25 

Article	ETRTO	Dimension	Color/sidewall	g	PSI	RRP/€
0150498	32-622	28 x 1¼ x 1¼	● Wire refl.	635	65-94	40,99
0150269	37-622	28 x 1½ x 1½	● Wire refl.	715	56-70	40,99
0150268	42-622	28 x 1.60	● Wire refl.	870	51-85	40,99

SAFETY LEVEL



Safety  System 

CONTACT Spike 240

SafetySystem Breaker - 3/180 TPI

E25 

Article	ETRTO	Dimension	Color/sidewall	g	PSI	RRP/€
0150091	37-622	28 x 1½ x 1½	● Wire refl.	715	56-70	54,99
0150191	42-622	28 x 1.60	● Wire refl.	870	51-85	54,99

SAFETY LEVEL





Top CONTACT II und Top CONTACT Winter II Premium **THE PROVEN FAST TREKKING ALL-ROUNDER**

Premium-allrounder: Riding fast and safe on the road, gravel or forest paths. Outstanding rolling characteristics fostered by a broad central tread pattern and a high-end fabric breaker.

The Top CONTACT Winter II Premium benefits from our know-how as leading manufacturer of winter tires for cars and trucks and offers full control on slippery, snowy roads and surfaces thanks to its grippy lamellar tread pattern.

ECE-R75-certified: Recommended for e-bikes up to 50km/h.



Top CONTACT II							
Vectran Breaker - 3/180 TPI							E50 U6
Article	ETRTO	Dimension	Color/sidewall	g	PSI	kg+	RRP/€
0101735	50-559	26 x 2.00	● foldable refl.	715	45-65	109	59,99
0100615	28-622	28 x 1¼ x 1¼	● foldable refl.	455	80-102	85	59,99
0100573	32-622	28 x 1¼ x 1¼	● foldable refl.	510	70-85	85	59,99
0100441	37-622	28 x 1¼ x 1¼	● foldable refl.	590	58-85	85	59,99
0100358	42-622	28 x 1.60	● foldable refl.	725	51-85	85	59,99
0100439	47-622	28 x 1.75	● foldable refl.	745	45-65	95	59,99



Top CONTACT Winter II Premium							
Vectran Breaker - 3/180 TPI							E50 U6
Article	ETRTO	Dimension	Color/sidewall	g	PSI	kg+	RRP/€
0100712	50-559	26 x 1.90	● foldable refl.	610	45-58	121	65,99
0101734	55-559	26 x 2.20	● foldable refl.	745	45-58	128	65,99
0101281	50-584	27,5 x 2.00	● foldable refl.	640	45-65	121	65,99
0100713	37-622	28 x 1¼ x 1¼	● foldable refl.	470	58-85	95	65,99
0100714	42-622	28 x 1.60	● foldable refl.	685	51-85	100	65,99





Super Sport Plus

FIXIE OR RACING BIKE? SUPER FAST AND SUPER RELIABLE FROM A TO B

Fast on tarmac and bicycle paths with its special slick tread pattern. Longevity and high puncture protection are the main focus. A reliable companion also for newcomers to cycling.



Super Sport Plus

Plus Breaker - 3/84 TPI

Article	ETRTO	Dimension	Color/sidewall	g	PSI	RRP/€
0100341	23-622	700 x 23C	● foldable	380	110-120	33,99
0100344	23-622	700 x 23C	● Wire	440	110-120	28,99
0100343	25-622	700 x 25C	● foldable	425	95-120	33,99
0100342	25-622	700 x 25C	● Wire	485	95-120	28,99
0100349	28-622	700 x 28C	● Wire	565	80-115	28,99
0100347	28-630	27 x 1½	● Wire	590	80-115	28,99
0100348	32-630	27 x 1¼	● Wire	635	70-102	28,99

Developed together with
schindelhauer



Grand Prix Urban

THE STATEMENT TIRE FOR THE CITY

Combines a modern tread pattern design with the latest technology. Built with a tuned race construction while damping for comfort – a matching mix for the urban ride. Its black reflective stripe blends perfectly with the sidewall.



Grand Prix Urban

BlackChili Compound - PolyX Breaker - 3/180 TPI

Article	ETRTO	Dimension	Color/sidewall	g	PSI	RRP/€
0101575	35-622	28 x 1 $\frac{1}{8}$ x 1 $\frac{1}{8}$	● foldable	345	65-85	53,99
0101673	35-622	28 x 1 $\frac{1}{8}$ x 1 $\frac{1}{8}$	● foldable	335	65-85	57,99



Urban TaraxaGum

GIVE SOMETHING BACK TO YOUR CITY!

The Urban Taraxagum is the first serial product made of dandelion rubber combining local production with minimal transport distances in the supply chain - ideal for the urban ride.

Vectran™ BREAKER **TARAXAGUM** 

Urban Taraxagum

Taraxagum™ - Vectran Breaker - 3/180 TPI

Article	ETRTO	Dimension	Color/sidewall	g	PSI	RRP/€
0101675	35-622	28 x 1 $\frac{1}{8}$ x 1 $\frac{1}{8}$	● foldable	345	65-85	65,99



RIDE Tour A LOYAL COMPANION ON YOUR REGULAR RIDES

Tarmac, gravel, urban environment - the right tire for your daily ride thanks to robust puncture protection and an additional rubber layer for high mileage. Available in a large range of colors and sizes.



RIDE Tour							E25		U5				
ExtraPuncture Belt - 3/180 TPI													
Article	ETRTO	Dimension	Color/sidewall	g	PSI	RRP/€	Article	ETRTO	Dimension	Color/sidewall	g	PSI	RRP/€
0101137	62-203	12½ x 2¼	● Wire	405	45-58	14,99	0101180	37-622	28 x 1¼ x 1¼	● Wire	725	56-70	21,99
0101138	47-305	16 x 1.75	● Wire	490	45-58	14,99	0101193	37-622	28 x 1¼ x 1¼	◐ Wire	725	56-70	21,99
0101140	47-406	20 x 1.75	● Wire	600	45-58	14,99	0101182	37-622	28 x 1¼ x 1¼	● Wire refl.	725	56-70	24,99
0101184	47-406	20 x 1.75	◐ Wire	630	45-58	14,99	0101177	37-622	28 x 1¼ x 1¼	● Wire	725	56-70	21,99
0101143	47-507	24 x 1.75	● Wire	720	45-58	15,99	0101167	42-622	28 x 1.60	● Wire refl.	790	51-65	24,99
0101186	47-507	24 x 1.75	◐ Wire	810	45-58	15,99	0101157	42-622	28 x 1.60	● Wire	790	51-65	21,99
0101148	47-559	26 x 1.75	● Wire	780	45-58	21,99	0101176	42-622	28 x 1.60	● Wire refl.	790	51-65	24,99
0101181	47-559	26 x 1.75	● Wire	870	45-58	21,99	0101160	47-622	28 x 1.75	● Wire refl.	900	45-58	24,99
0101189	47-559	26 x 1.75	◐ Wire	870	45-58	21,99	0101159	47-622	28 x 1.75	● Wire	900	45-58	21,99
0101175	47-559	26 x 1.75	● Wire refl.	870	45-58	24,99	0100375	47-622	28 x 1.75	● Wire	920	45-58	21,99
0101187	37-584	26/27.5 x 1¼	◐ Wire	690	56-70	21,99	0101179	47-622	28 x 1.75	● Wire	960	45-58	21,99
0101146	42-584	26/27.5 x 1½	● Wire	720	51-65	21,99	0101194	47-622	28 x 1.75	◐ Wire	960	45-58	21,99
0101150	54-584	26/27.5 x 1½ x 2	● Wire	950	45-58	21,99	0101185	47-622	28 x 1.75	● Wire	960	45-58	21,99
0101433	37-609	27 x 1¼ x 1½	● Wire	685	56-70	21,99	0101162	32-630	27 x 1¼	● Wire refl.	660	70-80	24,99
0101151	28-622	28 x 1¼ x 1¼	● Wire	540	70-102	21,99	0101161	32-630	27 x 1¼	● Wire	660	70-80	21,99
0101153	32-622	28 x 1¼ x 1¼	● Wire	640	70-80	21,99	0101183	32-630	27 x 1¼	◐ Wire	610	70-80	21,99
0101188	32-622	28 x 1¼ x 1¼	◐ Wire	600	70-80	21,99	0101163	37-635	28 x 1¼	● Wire	710	56-70	21,99
0101155	37-622	28 x 1¼ x 1¼	● Wire	690	56-70	21,99	0101165	42-635	28 x 1½	● Wire	820	51-65	21,99



RIDE City

A ROBUST TIRE WITH A MODERN LOOK

High reliability and always on time in urban traffic: Solid tire for city bikes. Proven successful on tarmac as well as on gravel thanks to good traction provided by its broad contact area in the tread pattern.



RIDE City

ExtraPuncture Belt - 3/180 TPI

E25 **U5**

Article	ETRTO	Dimension	Color/sidewall	g	PSI	RRP/€
0101552	47-559	26 x 1.75	● Wire refl.	940	45-58	24,99
0101554	37-622	28 x 1 $\frac{1}{8}$ x 1 $\frac{1}{8}$	● Wire refl.	850	51-65	24,99
0101555	42-622	28 x 1.60	● Wire refl.	950	51-65	24,99
0101556	47-622	28 x 1.75	● Wire refl.	1100	45-58	24,99

SAFETY LEVEL



TUBULAR



[instagram.com/conti_road](https://www.instagram.com/conti_road)



Competition

IT'S TIME TO RACE: THE CLASSIC FOR STRONG ACCELERATION

Robust all-rounder appearing at the sharp end in all the major cycling races around the world. Agile and fast, adapts to the competition in all road conditions.



Competition

BlackChili Compound - Vectran Breaker - 3/180 TPI

Article	ETRTO	Dimension	Color/sidewall	g	PSI	RRP/€
0196140		28 x 19	●	190	145-170	109,99
0196138		28 x 22	●	225	115-170	109,99
0196189		28 x 25	●	240	115-170	109,99

NOVELTY



Competition TT EVEN FASTER

Even faster time trial tire due to the delicate carcass. Excellent acceleration thanks to the application of a latex tube. Design updated to a smooth central tread pattern.

! Please consider the special attributes of latex tubes.



Vectran™
BREAKER

Competition TT

NEW

BlackChili Compound - Vectran Breaker - 3/180 TPI

Article	ETRTO	Dimension	Color/sidewall	g	PSI	RRP/€
0196270		28 x 25	●	190	115-170	109,99



Sprinter

FAST SPRINTER, FOR WINNING THE POINTS

Efficient tires for criteriums or triathlon where the tires winning characteristics will shine through. Neutral slick profile for a direct feel with the road. Full speed ahead!



Sprinter

BlackChili Compound - SafetySystem Breaker - 3/180 TPI

Article	ETRTO	Dimension	Color/sidewall	g	PSI	RRP/€
0196150		26 x 22	●	255	145-170	59,99
0196135		28 x 22	●	270	115-170	59,99
0196244		28 x 25	●	285	115-170	59,99



Sprinter Gatorskin

THE ROBUST SPRINTER, CREATED FOR EXTENDED RIDES AND TRAINING

The roads of Flanders, Roubaix and San Remo are home to this tough tubular. Durable and puncture protected carcass, ready for hundreds of kilometres, even on bad roads.



Safety System  DuraSkin®

Sprinter Gatorskin

SafetySystem Breaker - 3/180 TPI

Article	ETRTO	Dimension	Color/sidewall	g	PSI	RRP/€
0196136		28 x 22	●	265	115-170	65,99
0196187		28 x 25	●	275	115-170	65,99



Giro FOR NEWCOMERS: THE PERFECT COMPANION FOR TRAINING AND LEISURE RIDES

A reliable all-round tire, high quality for newcomers with high aspirations. High mileage and excellent value for money.

Giro

Performance - 2/160 TPI

Article	ETRTO	Dimension	Color/sidewall	g	PSI	RRP/€
0196017		28 x 22	●	390	115-145	35,99



Sonderklasse II

WITH ITS SINGLE MINDED DESIGN, THE SIX DAY HERO OF THE WOODEN BOARDS

Extremely light and fast handling tire - made for endurance racing on the wooden boards. A special slick profile for the highest speeds puts this tire into a class of its own in our track racing range.



Sonderklasse II

BlackChili Compound - 3/180 TPI

Article	ETRTO	Dimension	Color/sidewall	g	PSI	RRP/€
0196188		28 x 23	●	195	160-170	120,99



Tempo II

THE VELODROME ALL-ROUNDER FOR ALL TRACK DISCIPLINES

Particularly light and fast racing tire designed for the concrete and wooden surfaces of velodromes. No compromise design: made with a particularly fine carcass and a slightly roughened slick tread.



Tempo II

BlackChili Compound - 3/180 TPI

Article	ETRTO	Dimension	Color/sidewall	g	PSI	RRP/€
0196185		28 x 19	●	185	160-220	103,99
0196184		28 x 22	●	200	160-170	103,99

PREMIER

SUITABLE FOR E-BIKES

For our E-Bike tire we fall back on over 100 years' experience with moped and motorcycle tires. All of our urban/tour tires are rated to a standard speed of at least 25 km/h. Those tires marked e50 are also certified for S-Pedelecs. With their high quality structure, puncture protection is high and the rolling resistance is low offering protection from premature wear brought about by the additional driving force.



eRuban
> Page 17

eCONTACT Plus
> Page 35

CONTACT Plus City
> Page 37

Top CONTACT II
> Page 42

Grand Prix 5000
> Page 21

CONTACT Plus
> Page 36

CONTACT Urban
> Page 39

Top CONTACT Winter II Premium
> Page 42





Mountain King
> Page 13

● ●
Race King
> Page 15

● ● ● ●
Terra Speed
> Page 31

Terra Hardpack
> Page 33

Cross King
> Page 14

● ●
Ultra Sport III
> Page 25

● ● ● ●
Terra Trail
> Page 32



TIRES & SIZES

12"	42-559	32-630	55-584
62-203	CONTACT Speed	Gatorskin	Race King ShieldWall
RIDE Tour	47-559	Super Sport Plus	Race King
16"	Hometrainer II	RIDE Tour	eCONTACT Plus
35-349	CONTACT Plus	37-609	CONTACT Plus City
CONTACT Urban	CONTACT Plus City	RIDE Tour	CONTACT Urban
47-305	CONTACT	27.5"	58-584
RIDE Tour	CONTACT Urban	25-584	Ruban
20"	RIDE Tour	Grand Prix 5000	Ruban ShieldWall
28-406	RIDE City	Ultra Sport III	Mountain King ProTecton
CONTACT Speed	50-559	28-584	Mountain King ShieldWall
32-406	Cross King ShieldWall	Grand Prix 5000	Mountain King
CONTACT Urban	Race King ShieldWall	Ultra Sport III	Cross King ProTecton
37-406	Top CONTACT II	30-584	Cross King ShieldWall
CONTACT	Top CONTACT Winter II Premium	Grand Prix 5000 S TR	Cross King
42-406	CONTACT Urban	32-584	60-584
CONTACT Urban	CONTACT Speed	Grand Prix 5000 S TR	Xynotal
47-406	55-559	CONTACT Speed	Kryptotal Fr
RIDE Tour	Cross King ProTecton	35-584	Kryptotal Re
50-406	Cross King ShieldWall	Terra Speed ProTecton	Argotal
eCONTACT Plus	Top CONTACT Winter II Premium	40-584	Hydrotal
CONTACT Urban	CONTACT Urban	Terra Trail ProTecton	62-584
55-406	58-559	Terra Speed ProTecton	eCONTACT Plus
eCONTACT Plus	Mountain King ProTecton	42-584	CONTACT Urban
62-406	Mountain King ShieldWall	CONTACT Urban	65-584
eCONTACT Plus	Cross King ProTecton	47-584	Kryptotal Re
24"	Cross King ShieldWall	Terra Trail ShieldWall	Argotal
47-507	Cross King	50-584	Ruban
RIDE Tour	26/27.5"	Hometrainer II	Ruban ShieldWall
26"	37-584	Cross King ShieldWall	Mountain King ProTecton
23-571	RIDE Tour	Race King ShieldWall	Mountain King ShieldWall
Grand Prix	42-584	Top CONTACT Winter II Premium	Cross King ProTecton
Gatorskin	RIDE Tour	CONTACT Urban	Cross King ShieldWall
26 x 22	54-584	CONTACT Speed	70-584
Sprinter	RIDE Tour	54-584	Mountain King ProTecton
28-559	27"	Ruban ShieldWall	Mountain King ShieldWall
Grand Prix	28-630	55-584	Cross King ProTecton
Gatorskin	Super Sport Plus	Cross King ProTecton	Cross King ShieldWall
32-559	32-630	Cross King ShieldWall	
CONTACT Speed	Gator Hardshell	Race King ProTecton	

28"	28 x 22	37-622	55-622
23-622	Sprinter	CONTACT Speed	CONTACT Cruiser
Grand Prix 5000	Sprinter Gatorskin	CONTACT Spike 120	RIDE Cruiser
Grand Prix 4-Season	Giro	CONTACT Spike 240	62-622
Grand Prix	Tempo II	RIDE Tour	eCONTACT Plus
Gator Hardshell	28 x 23	RIDE City	CONTACT Urban
Gator Hardshell Black Edition	Sonderklasse II	37-635	29"
Gatorskin	28 x 25	RIDE Tour	50-622
Gatorskin Black Edition	Competition	40-622	Cross King ShieldWall
Grand Sport Race	Sprinter	Terra Trail ProTecton	Race King ShieldWall
Ultra Sport III	Sprinter Gatorskin	Terra Speed ProTecton	54-622
Hometrainer II	30-622	Terra Trail ShieldWall	Ruban
Super Sport Plus	Grand Prix 5000	CONTACT Urban	Ruban ShieldWall
25-622	Grand Prix 5000 S TR	42-622	55-622
Grand Prix 5000	32-622	Top CONTACT II	Cross King ProTecton
Grand Prix 4-Season	Grand Prix 5000	Top CONTACT Winter II Premium	Cross King ShieldWall
Grand Prix	Grand Prix 5000 S TR	CONTACT Plus	Cross King
Gator Hardshell	Grand Prix 5000 All Season TR	CONTACT Plus City	Race King ProTecton
Gator Hardshell Black Edition	Grand Prix 4-Season	CONTACT	Race King ShieldWall
Gatorskin	Gator Hardshell	CONTACT Urban	Race King
Gatorskin Black Edition	Gator Hardshell Black Edition	CONTACT Speed	58-622
Grand Sport Race	Gatorskin	CONTACT Spike 120	Ruban
Ultra Sport III	Gatorskin Black Edition	CONTACT Spike 240	Ruban ShieldWall
Super Sport Plus	Grand Sport Race	RIDE Tour	Mountain King ProTecton
28-622	Hometrainer II	RIDE City	Mountain King ShieldWall
Grand Prix 5000	Top CONTACT II	42-635	Mountain King
Grand Prix 4-Season	CONTACT	CONTACT Plus	Cross King ProTecton
Grand Prix	CONTACT Urban	RIDE Tour	Cross King ShieldWall
Gator Hardshell	CONTACT Speed	45-622	Cross King
Gator Hardshell Black Edition	CONTACT Spike 120	Terra Trail ShieldWall	60-622
Gatorskin	RIDE Tour	Terra Speed ProTecton	Xynotal
Gatorskin Black Edition	35-622	47-622	Kryptotal Fr
Grand Sport Race	Grand Prix 5000 All Season TR	Top CONTACT II	Kryptotal Re
Ultra Sport III	Grand Prix Urban	CONTACT Plus	Argotal
Top CONTACT II	Urban TaraxaGum	CONTACT Plus City	Hydrotal
Super Sport Plus	Terra Speed ProTecton	CONTACT	65-622
CONTACT	Terra Trail ShieldWall	CONTACT Urban	Kryptotal Re
CONTACT Urban	CONTACT Urban	RIDE Tour	Argotal
CONTACT Speed	37-622	RIDE City	Ruban ShieldWall
RIDE Tour	Top CONTACT II	50-622	Cross King ShieldWall
28 x 19	Top CONTACT Winter II Premium	Terra Hardpack ShieldWall	
Competition	CONTACT Plus	eCONTACT Plus	
Tempo II	CONTACT Plus City	CONTACT Urban	
28 x 22	CONTACT	55-622	
Competition	CONTACT Urban	CONTACT Urban	

TUBES

With the ContiTube program, you can find the inner tube most suited to your needs. Depending on your tire dimensions and purpose, different sizes, types, valve types and widths are available.

All

The all-rounder for day to day demands. Available in all usual dimensions.

Light und Supersonic

Perceptible optimization of weight and rolling resistance due to thinner material. ! Light tubes generally require more frequent reinflating.

Hermetic Plus

The all-round carefree product. Designed for the most comprehensive puncture protection and air retention due to enhanced butyl content and increased wall thickness.

Freeride und Downhill

Extra strong and increased volume. Effectively protects against punctures thanks to thicker material.



Auto Schrader



Blitz Dunlop



Sclaverand Presta



Sclaverand Presta



Sclaverand Presta

A34

A34 45°

A40

D26

D40

S42

S60

S80

Workshop (50 Stück/VE)

ETRTO	Version	Article	Article	Article	Article	Article	Article	Article	Article	g
26"										
47-559->62-559	MTB			0180581		0180521	0180551			205
26" (27.5")										
37-559->47-597	Tour					0180621				175
	Tour Hermetic Plus					0180751				255
27.5"										
47-584->62-584	MTB						0182351			230
28" / 29"										
18-622->25/630	Race						0180591	0180611	0180024	100
32-622->47-642	Tour			0180691		0180651	0180681			165
	Tour Hermetic Plus			0180721		0180711				225
47-622->62-622	MTB						0182361			235



Auto Schrader



Blitz Dunlop



Scalverand Presta



Scalverand Presta



Scalverand Presta

ETRTO	Version	A34 Article	A34 45° Article	A40 Article	D26 Article	D40 Article	S42 Article	S60 Article	S80 Article	g	RRP €
Race 26"											
20-559->25-571							0181371	0181381		95	ab 7,50
	Light						0181391	0181411		65	ab 9,50
	Supersonic						0181421	0181431		50	ab 13,50
Race 28"											
20-622->25-630							0181781	0181791	0180000	100	ab 7,50
	Light						0181821	0181831	0181871	65	ab 9,50
	Supersonic						0181881	0181891		50	ab 13,50
25-622->32-630	Wide						0181921	0181931		125	ab 7,50
Cross 28"											
32-622->47-622							0181941	0181951		160	ab 7,50
MTB 26"											
47-559->62-559				0181611		0181621	0181631	0181671		205	ab 7,50
47-559->60-559	Light						0181681			125	9,50
47-559->55-559	Supersonic						0181691			100	13,50
57-559->70-559	Freeride			0181721			0181731			295	12,50
	Downhill			0181771						535	12,50
MTB 27.5"											
47-584->62-584				0182331			0182311			230	7,50
47-584->60-584	Light						0182341			145	9,50
65-584->70-584	Wide			0180017			0180015			345	9,50
	Wide Light						0180019			275	9,50
MTB 29"											
47-622->62-622				0182171		0183051	0182181	0182191		230	ab 7,50
47-622->60-622	Light						0182321	0182201		190	ab 9,50
65-622->70-622	Wide			0180031			0180034			345	9,50
Tour 26"											
28-559->32-597	Slim					0181471	0181481			145	7,50
37-559->47-590	All			0181491		0181511	0181521			175	7,50
47-559->62-559	Wide			0181531		0181571	0181591			200	7,50
Tour 28"											
28-622->37-622/32-630	Slim			0181971		0181981	0181991			140	7,50
32-622->47-622/42-635	All			0182001		0182021	0182031	0182041		165	ab 7,50
	Light			0182051		0182061	0182071			115	9,50
47-622->62-622	Wide			0182121		0182131	0182161			230	7,50
Hermetic Plus											
ETRTO	Version	Article	Article	Article	Article	Article	Article	Article	Article	g	RRP €
Compact 20"											
32-406->47-451		0180037				0180039				190	9,50
50-406->62-406	Wide	0180042				0180045				230	9,50
Compact 24"											
32-507->47-544				0182231		0182241				235	9,50
55-507->62-507	Wide			0182581						370	9,50
Tour 26"											
37-559->47-590	All			0182251		0182261	0182271			255	9,50
47-559->62-559	Wide					0181581				300	9,50
Tour 28"											
32-622->47-622/42-635	All			0182101		0182081	0182091			225	9,50
47-622->62-622	Wide					0182151				325	9,50
Compact Tubes											
ETRTO	Version	Article	Article	Article	Article	Article	Article	Article	Article	g	RRP €
Compact 8"											
54-110					0180991					70	7,50
Compact 10" / 11" / 12"											
44-194->62-222		0181051	0182211		0181071					95	7,50
Compact 14"											
32-279->47-298					0181081					100	7,50
Compact 16"											
32-305->47-349		0181091			0181111		0181121			110	7,50
50-305->62-305	Wide	0181131			0181171					120	7,50
Compact 18"											
32-355->47-400				0180026	0181181					125	7,50
Compact 20"											
28-406->32-451	Slim						0181191			105	7,50
32-406->47-451		0181211				0181221	0181231			135	7,50
50-406->62-406	Wide	0181271				0181281				155	7,50
Compact 24"											
32-507->47-544				0181291		0181311	0180027			155	7,50
50-507->60-507	Wide			0181321		0181331				195	7,50

ACCESSORIES

RIM STRIP

The non visible component, but with a huge effect. A missing or badly chosen rim tape is the cause of many punctures. For rims with spoke holes it is particularly important to use a tape that remains stable under pressure and one which covers the entire rim base. The fabric-reinforced Continental EasyTape was specially developed for use under high pressure conditions. Various widths allow a perfect fit to be achieved in all common rim types. The high pressure version for racing bikes can withstand pressures up to 220 PSI without deformation. Its wafer-thin profile also allows the tire to be mounted much easier.



Easy Tape Rim Strip < 116 PSI

Article	ETRTO	Version	PU	RRP €
0195000	20-559	Set Box 2 Pcs	1	5,00
0195002	22-559	Set Box 2 Pcs	1	5,00
0195006	24-559	Set Box 2 Pcs	1	5,00
0195009	26-559	Set Box 2 Pcs	1	5,00
0195035	18-584	Set Box 2 Pcs	1	5,00
0195038	20-584	Set Box 2 Pcs	1	5,00
0195043	22-584	Set Box 2 Pcs	1	5,00
0195048	24-584	Set Box 2 Pcs	1	5,00
0195049	26-584	Set Box 2 Pcs	1	5,00
0195027	14-622	Set Box 2 Pcs	1	5,00
0195013	18-622	Set Box 2 Pcs	1	5,00
0195015	20-622	Set Box 2 Pcs	1	5,00
0195018	22-622	Set Box 2 Pcs	1	5,00
0195022	24-622	Set Box 2 Pcs	1	5,00
0195025	26-622	Set Box 2 Pcs	1	5,00

Easy Tape Rim Strip High Pressure < 220 PSI

Article	ETRTO	Version	PU	RRP €
0195066	16-622	Set 2 Pcs	1	5,65
0195070	18-622	Set 2 Pcs	1	5,65

CONTI REVOSEALANT

Punctures and small cuts? The ammonia and protein-free RevoSealant reliably seals holes without attacking the tire or tube chemically. RevoSealant was developed specifically for our MTB TR and Road TL systems. In addition it effectively prevents punctures and repairs tubulars and tubes.

Continental RevoSealant

Article	Version	PU	RRP €
0140050	1000 ml	6	34,90
0140044	240 ml	20	10,90
0140089	60 ml	12	6,90



Mounting

Article	Version	PU	RRP €
0140095	3 Pcs	3	6,90

Tire fitting/removing lever

Article	Version	PU	RRP €
0149090	MTB/Tour	50	0,90
0149093	Road	50	0,90



VENTILVERLÄNGERUNGEN

We offer a valve extension for every type of rim. What is required is a tube with a Presta valve which has an interchangeable insert. With the enclosed tool you can easily fit the valve extension yourself.

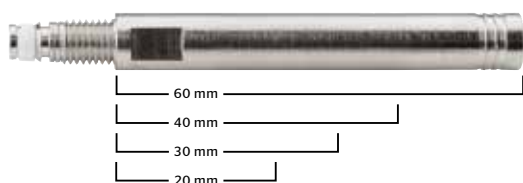

Valve extension Aluminium for presta valve

Article	Version	PU	RRP €
0140028	20 mm Set 2 Pcs	2	8,90
0140030	30 mm Set 2 Pcs	2	9,90
0140032	40 mm Set 2 Pcs	2	9,90
0140034	60 mm Set 2 Pcs	2	10,90



Rim Cement

Article	Product	Version	PU	RRP €
0140017	Carbon	200 g can	1	18,90
0140016	Carbon	12 tubes with 25 g each	12	2,90
0149092	Aluminium	350 g can	1	29,90
0149091	Aluminium	12 tubes with 25 g each	12	2,90



Valves & Co

Article	Version	PU	RRP €
0140090	Tubeless Ventile Set S40	2	23,90
0144690	Presta Valve Cores Set 10	1	5,90



Bag with tube and 2 tire levers

Article	Version	PU	RRP €
0101025	MTB 27.5" S42	1	10,90
0101026	MTB 29" S42	1	10,90
0100385	MTB 26" S42	1	10,90
0100388	Race 28" S42	1	9,90
0100384	Race 28" S60	1	11,90
0100448	Tour 28" D40	1	9,90

WHEELBAGS

Wheel bag with two padded compartments for MTB or racing tires [front + back] with reinforced carrier and shoulder straps. In Conti style, ideal for transporting tires and rims. With reflex stripes. Material: Made of a durable plastic.

Wheel bag

Article	Version	PU	RRP €
0140006	26"/ 28" Continental-Logo	1	61,90
0140011	27.5"/ 29" Black Chili-Logo	1	61,90



TECHNIC

BlackChili Compound

IT'S ALL ABOUT HOW YOU MIX IT

The rolling properties of the rubber compound of a tire are primarily determined by three interacting factors - stiction [grip], rolling resistance and mileage [longevity]. The dilemma: If you improve any of these factors it can have a detrimental effect on at least one of the others. A tire with maximum grip wears quicker and rolls more slowly. If you then make a tire roll faster and more durable, grip, in turn, is reduced.

With our BlackChili Compound, a tread compound which is always based on the latest knowledge of polymers and raw material research, we have supplied the cycling industry with an enduring solution.

Depending on the application of a tire, we adjust the compound formulation for the specific discipline - for road or mountain biking, time trialling or downhill racing.

How does that work? For BlackChili, we refine special synthetic rubbers with proven natural rubber to high-performance tread mixtures. To these mixtures we then add soot particles, which in turn are optimised in shape and surface properties. The complex compound technology is so sensitive that tires with BlackChili Compound are produced exclusively in our German Korbach plant.

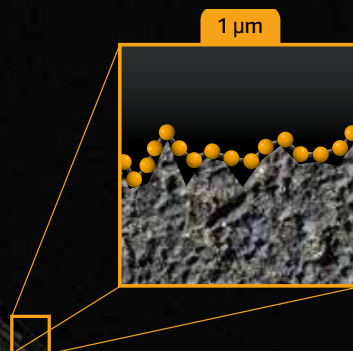

12% better rolling resistance*

thanks to our improved BlackChili compound

*compared to our former Grand Prix 4000S II

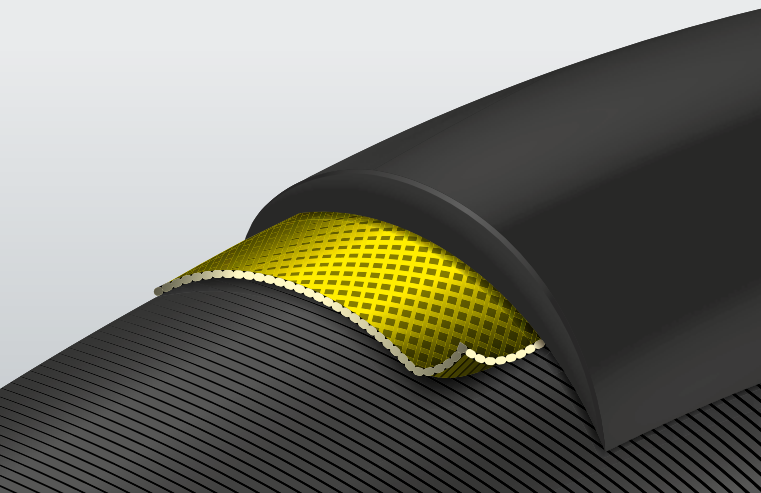

PolyX Breaker™ CUT AND PUNCTURE PROOF

With PolyX Breaker™ car expertise comes to the bicycle tire sector. Polyester has been used successfully for years in car tires and has proved extremely effective. The extremely resistant polyester fibre is woven tightly crosswise. A very high fabric density is achieved which makes the breaker resistant not only to foreign bodies, but especially to punctures. The rolling resistance is not affected by this breaker.

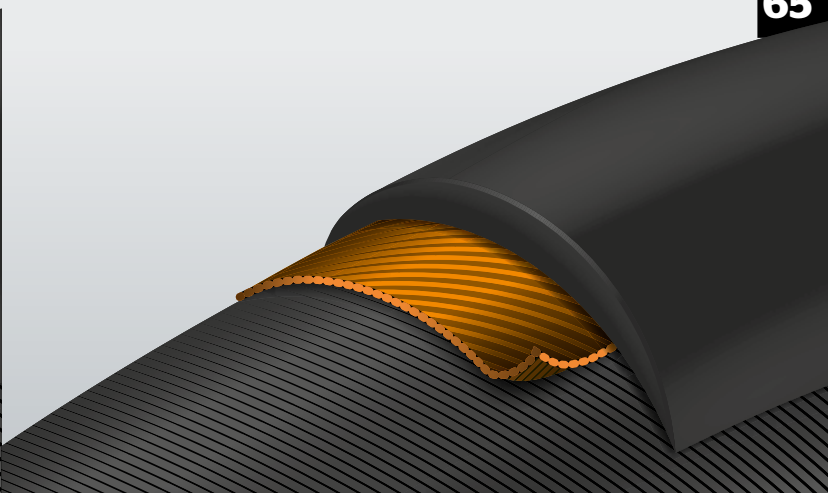

NyTech Breaker LIGHT AND SLEEK

The Nytech Breaker is based on the technology of our SafetySystem puncture protection. Made of nylon fibre and similar to Kevlar, it reliably protects against punctures and cuts. It also has particularly low rolling resistance and reduced weight, perfect for our performance range of road tires.

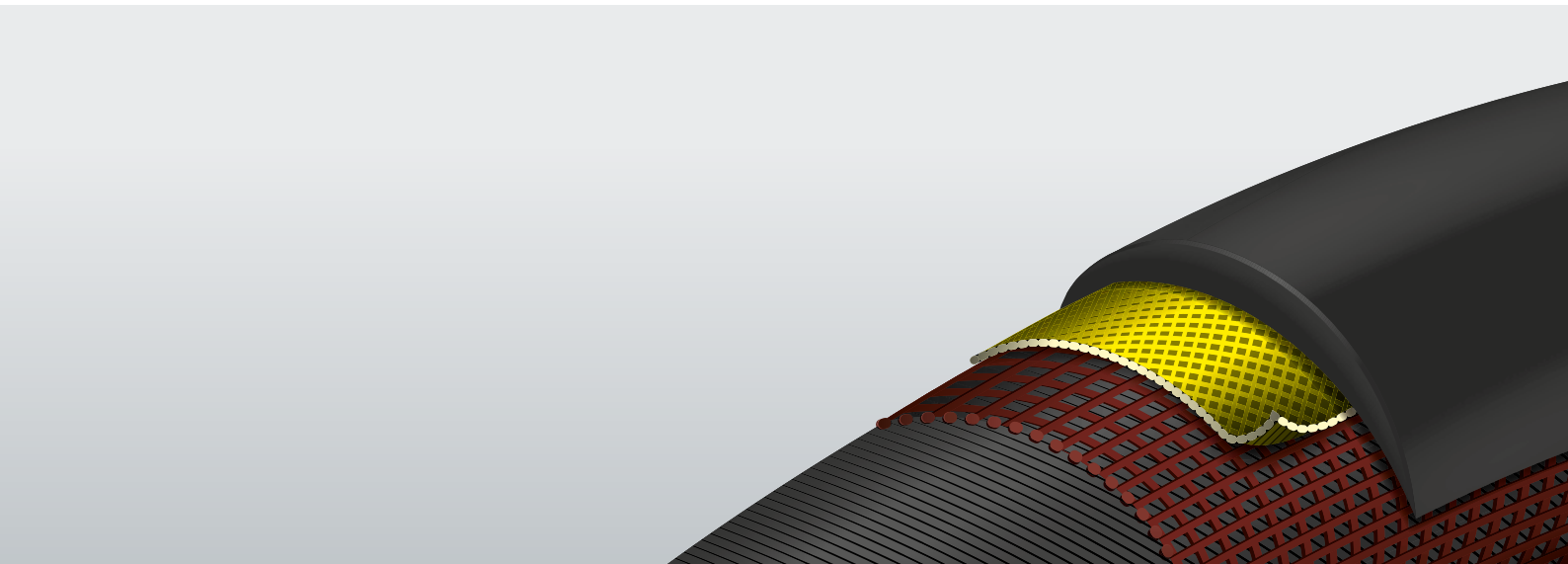

PureGrip Compound PURE GRIP FOR EVERYONE

PureGrip Compound is derived from an activated Silica compound and is a good example of how we integrate customer feedback continuously into our research and development. This mixture technology fits in perfectly alongside the BlackChili Compound. The name PureGrip does exactly what it says; exceptionally good grip and durability are the distinguishing features of this compound. Engineered with PureGrip in our Performance products in our road and mountain bike ranges.



Hardshell ProTection MORE IS WHAT YOU GET

Puncture protection and mileage are the strengths of Hardshell-ProTection. A wider PolyX Breaker™, the specialist against punctures, under the tread centre and shoulders provides for great reliability. The three-ply - each layer with 60 TPI - carcass covers the entire tire and makes it a real bastion against urban detritus. The outer sidewalls of the tire are reinforced with DuraSkin® fabric providing even more reliability due to the casing being so well protected. Hardshell tires are the puncture-resistant flagship amongst racing tires - produced exclusively in Germany.



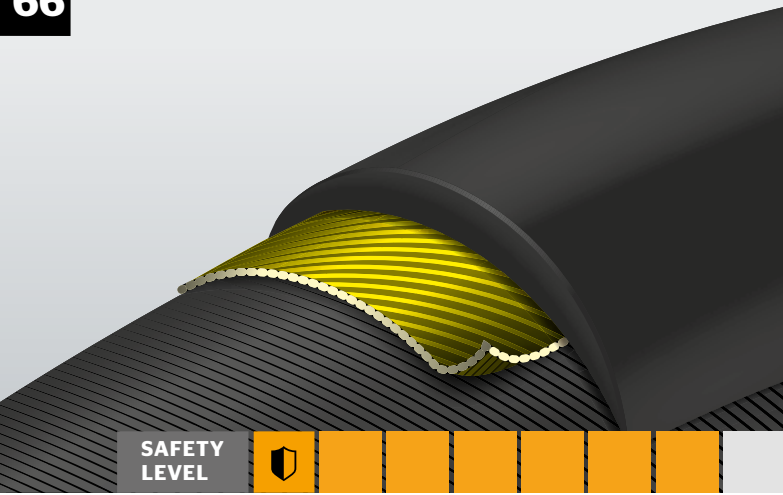

Vectran™ Breaker
PUNCTURE PROTECTION AT IT'S BEST

Vectran™ is spun from liquid crystal-polymer. This way a thermo-plastic, multiple-thread yarn is created. As a comparison: This partially crystalline fabric is more cut-resistant than aramide and its tensile strength is five times higher than that of steel. A Vectran™ Breaker is lighter, more flexible and effective against cuts than a comparable nylon breaker. Without effecting rolling resistance.

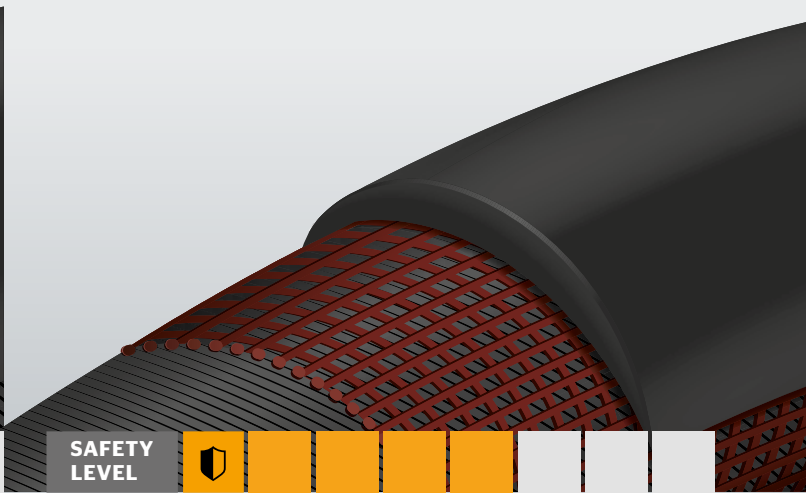

DuraSkin®
FOR HARD CASES

Tires with DuraSkin® sidewall protection can take a beating as they are designed for the most adverse conditions. In rough terrain on a cyclocross or a gravel bike, on commuter bikes where tires scrape along curbs, on touring bikes as they cross continents encountering many different road qualities and on the race circuit where they prove themselves in endurance events such as the Paris-Roubaix. The high-quality polyamide fabric reliably protects the wall of the tire. Tires with DuraSkin® can be identified by the characteristic brown mesh sidewall*.

**DuraSkin® comes in restrained black with our Black Edition*

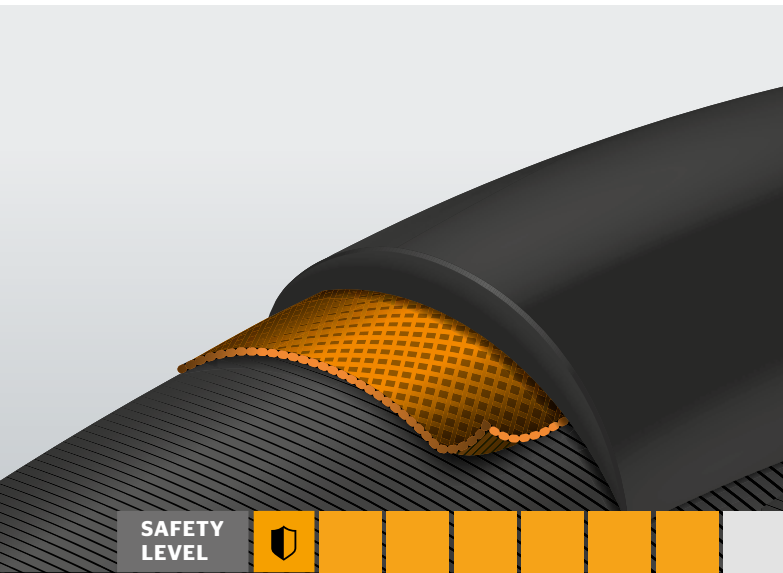

SafetyPro Breaker
LIGHTWEIGHT PUNCTURE PROTECTION

The new SafetyPro Breaker designed from nylon textile. Cross-woven textile fiber netting that is simultaneously robust and flexible. Maximum puncture protection with minimal added weight. The risk of punctures resulting from glass or sharp stones is substantially reduced.

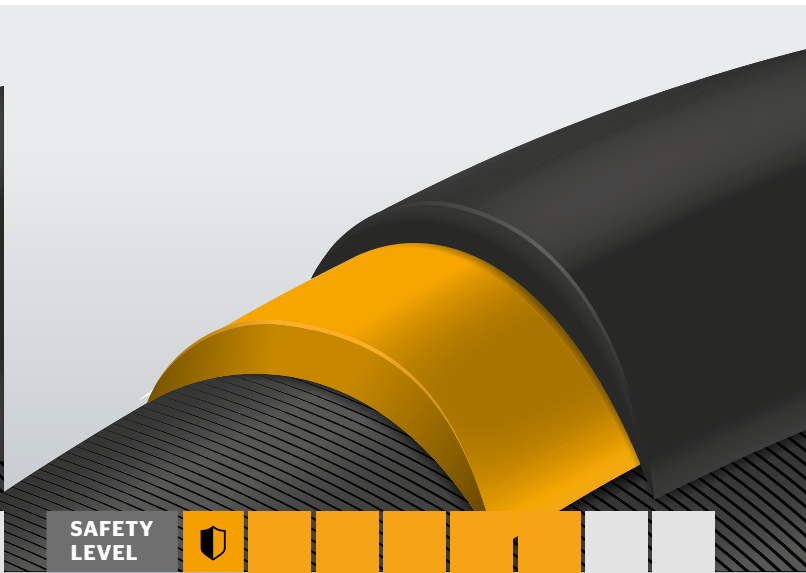

EXTRA PunctureBelt
CAREFREE ON A DAILY BASIS

Anyone looking for a reliable everyday companion will go for a tire with EXTRA PunctureBelt. This rugged rubber breaker, combined with the rubber-reinforced sidewalls of the tire, ensures a high level of puncture protection and sidewall abrasion. Where durability is the main focus, there is also a solid tire version.





Puncture ProTecton THE NAME SPEAKS FOR ITSELF

An impeccable rubber Breaker, created for the daily ride on your Urban/Tour bike. The breaker ensures a high level of puncture protection and sidewall abrasion.



Up to 30% higher puncture protection*
against glass and sharp flints!

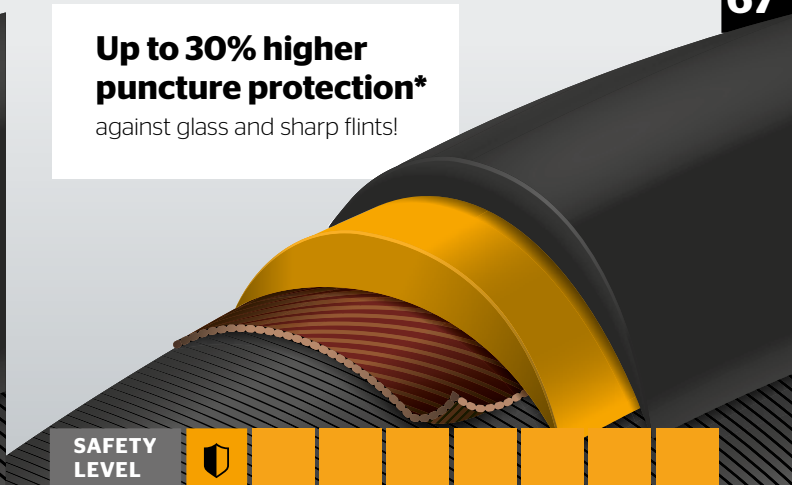

SafetyPlus Breaker THE ANTI-PUNCTURE SPECIALIST

Specially designed for e-bikes up to 50 km/h, we have combined our SafetySystem Breaker with a highly flexible natural rubber. The result is an extremely cut and puncture resistant breaker ply which has a low rolling resistance thanks to its high elasticity. This helps saving battery life and the environment. High acceleration torques and fast speeds in turns are easily absorbed by the breaker. The specialist for fast e-bikes and rental bikes.



* Benchmark test: Piercing (blade) test measuring force required, Zedler Institute, 2016 - further details of the test: www.continental-tires.com/bicycle/technology

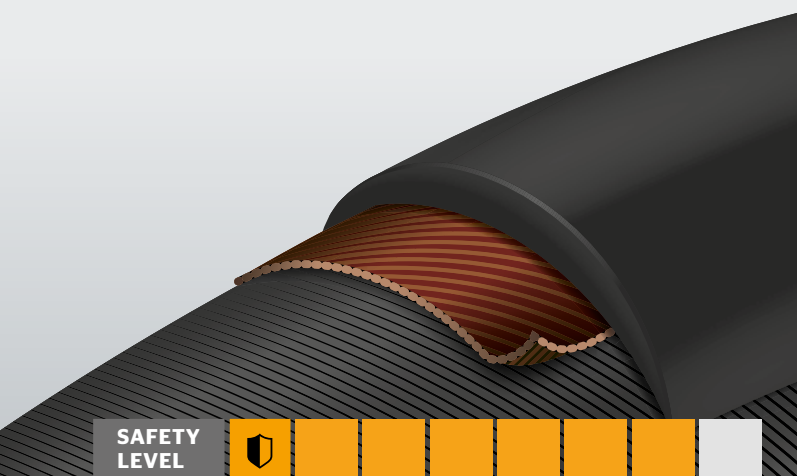

SafetySystem Breaker PUNCTURE PROTECTION AS A SYSTEM

The SafetySystem Breaker consists of a Kevlar-reinforced, high-strength nylon fabric. Puncture and cut resistant, whilst also being light and flexible, allowing the tire to adapt more effectively to the terrain. The breaker protects the carcass against foreign objects and contributes to a longer lifespan of the tire without significantly increasing weight or rolling resistance. Additionally, tires with SafetySystem have particularly comfortable handling characteristics.

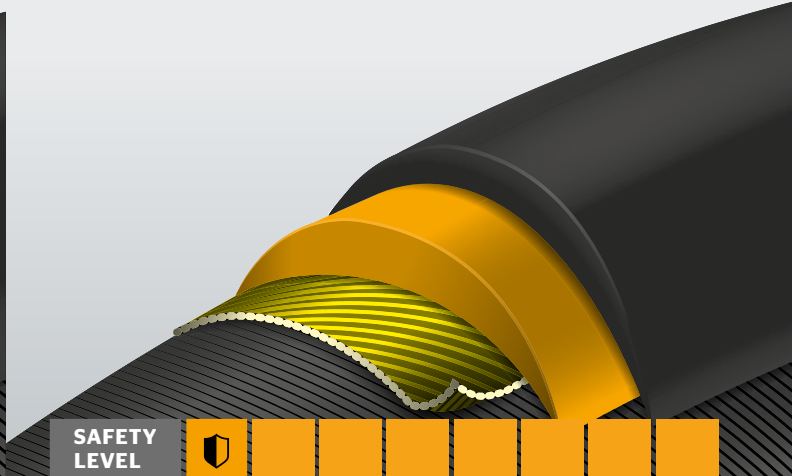

SafetyPlus Pro Breaker THE SPECIALIST FOR E-BIKES AND CARGO BIKES

Engineered for the unique demands of modern e-bikes and cargo bikes up to 50km/h. Our Safety Plus Pro Breaker technology combines highly flexible rubber with the proven strength of our tightly woven PolyX puncture-resistant fibers. The high elasticity keeps rolling resistance low, prolonging the e-bike battery life so you get more miles from each charge. When riding with heavy loads, the SafetyPlus Pro Breaker contributes to confident handling through busy traffic and sharp corners, no matter the conditions.



TECH SUPPORT

Mounting instruction Tubeless Ready tires



TIPS AND TRICKS

In individual cases where the tire bead does not properly sit on the inside of the rim, try unscrewing the valve nut and pushing the valve back.

Valves with a round rubber end have a lower volume than those with a rectangular rubber end. Maybe you could try to change your existing valve to fit your tire accordingly.

WATCH THE VIDEO



RECOMMENDED AMOUNTS OF SEALANT PER TIRE

ROAD	<i>Dimension</i>	<i>Filling amount</i>
	25 mm	30 - 60 ml
	28 mm	60 - 90 ml

MTB	<i>Dimension</i>	<i>Filling amount</i>
	2.0 - 2.1	80 - 100 ml
	2.2 - 2.3	100 - 120 ml
	2.4 - 2.5	120 - 150 ml
	2.6 - 2.8	150 - 180 ml

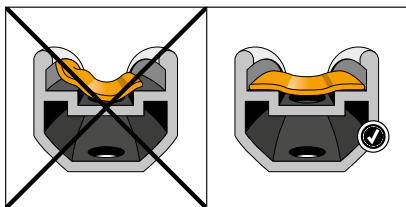

1 Check both rim and rim tape. Only use Tubeless ready rims. Ensure that the rim tape covers the rim well with at least two layers.

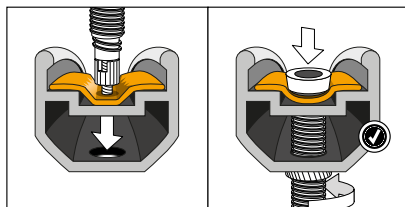

2 Mount the Tubeless valve first. Install it from the inside of the rim and tighten the nut. Press your finger on the rubber end of the valve to secure a better fit. Only tighten the nut by hand, do not use any tools.

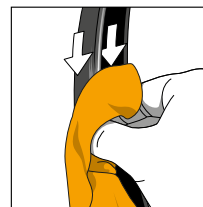

3 Before the initial inflation you can apply some soapy-water or a mounting pad on the contact points between tire and rim bed. This can help improve mounting the tire on the rim.

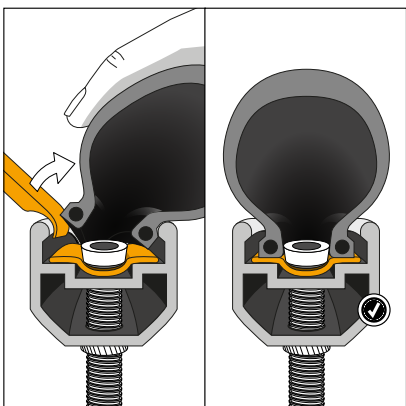

4 Mount the Tubeless tire on the rim in correct orientation of rotation. Ensure no loose pieces (e.g. sand, plastics) are found inside. Due to the tighter dimension tolerances of a Tubeless tire compared to a normal Clincher tire it may be helpful for you to use tire levers.

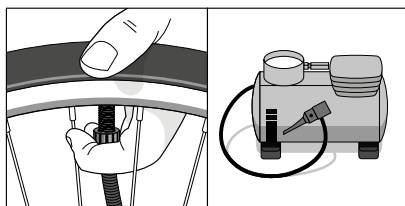

5 To fit the tire between the hooks, you may need a higher amount of air in the first instance. If you are using a floor pump, it is better to maintain a constant momentum within the first few seconds. A modern floor pump with a second inflatable cartridge can help to achieve this.

If a floor pump does not fill and accurately seat the tire, a compressor could help. You may need to adapt to the respective bicycle valve.

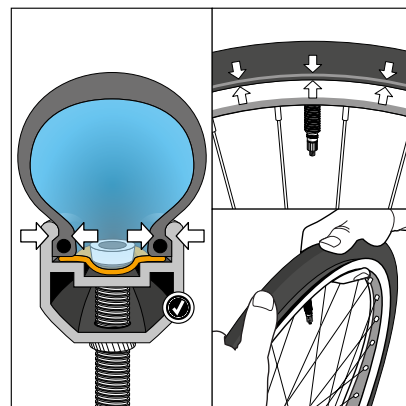
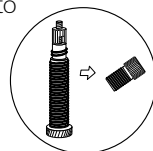

6 The correct fitting of the tire on the rim is mostly notable by a loud clicking noise. Check the air tightness of your Tubeless system. Does it lose any air? Check if the control line has an equal distance to the rim. If not release some air and work on the tire with both hands.

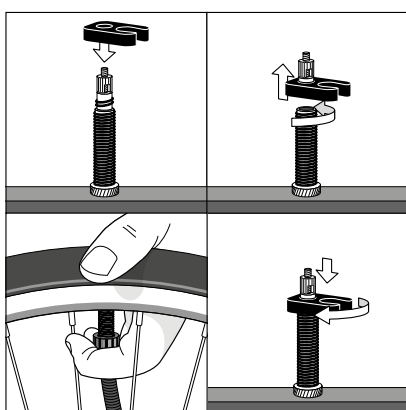

7 To enhance the air volume, unscrew the valve core. Pump it up and screw the valve core in again.



8 For the best puncture resistance, we recommend to fill approximately 30 - 60 ml of tire sealant through the valve. Considering it will dry over time, it is best to check and refill it every 3 - 6 months.

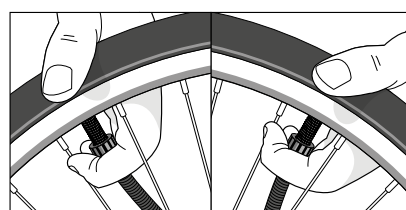

9 If you are using tire sealant: For inflation place the tire with the valve at the 11 or 1 o'clock position. Otherwise sealant could leak into the valve or put too much turbulence into it. It could dry faster or lock up the valve core.

Please be advised that the use of a CO2 cartridge can clump the sealant particles.

Important:

Do not insert the tire sealant with the valve at a 6 o'clock position! The valve should be located at the 5 or 7 o'clock position.

Continental Reifen Deutschland GmbH

Büttnerstraße 25

D-30165 Hannover

www.conti-bicycletires.com



Newsletter for
wholesale and retail

Subscribe here
with QR Code



Conti on Facebook

facebook.com/ContiBicycleTires

Subject to technical changes. No reliability for
printer's error.
07/22 Barthelmay & Habedank Design GmbH.

Vectran™ is the registered trademark of Kuraray
Co., Ltd.; Kevlar® is the registered trademark
of E. I. du Pont de Nemours and Company.

© Copyright 2022 by
Continental Reifen Deutschland GmbH,
30165 Hannover, Germany.